

# AE8

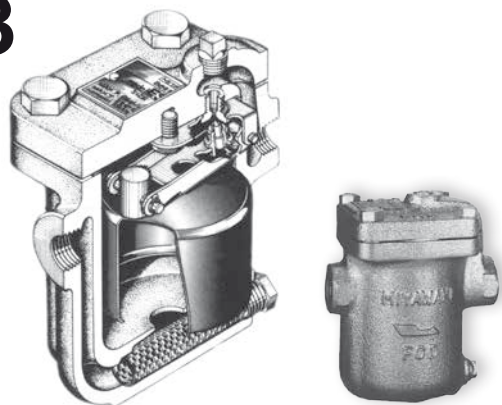

# AV

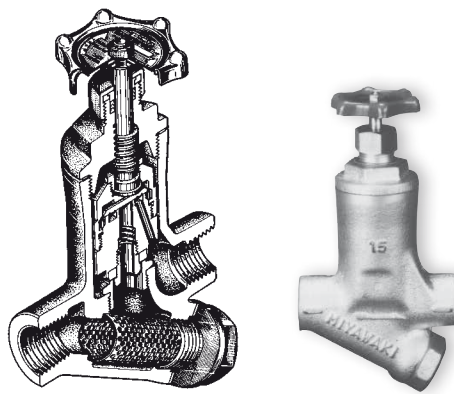

Capacity Chart AE8

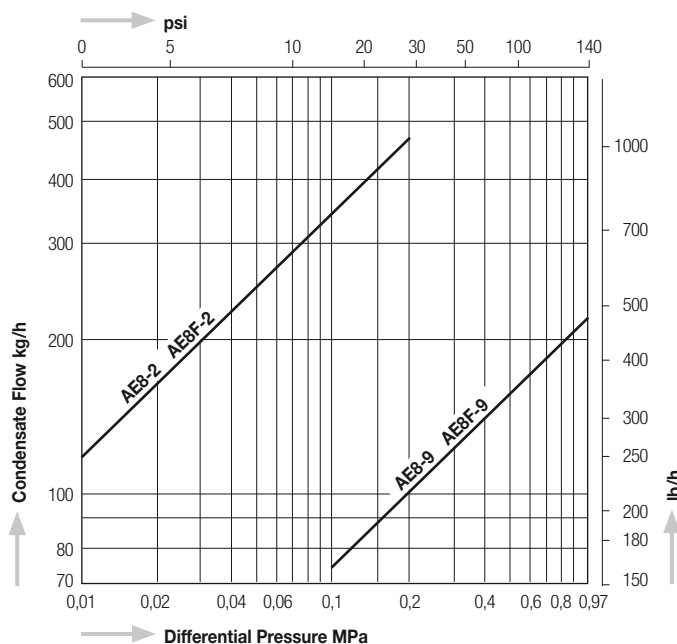

Capacity Chart AV

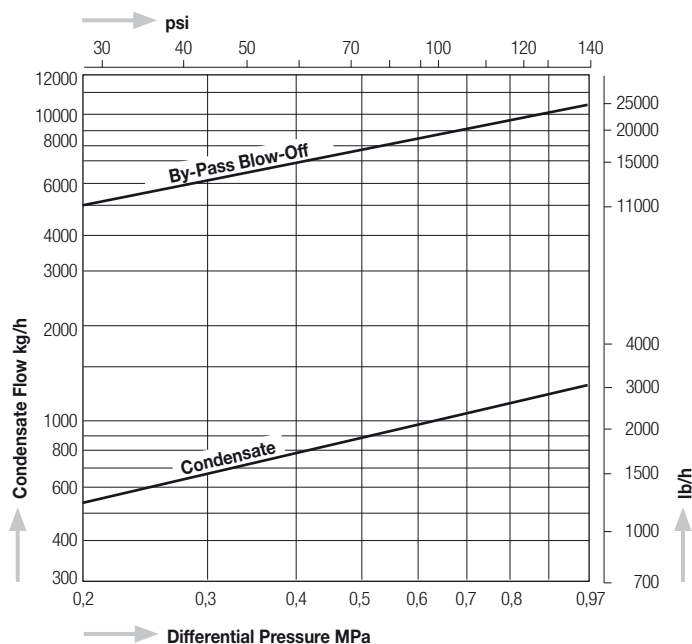

Dimensions

AE8

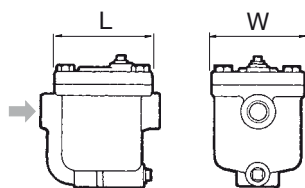

AE8F

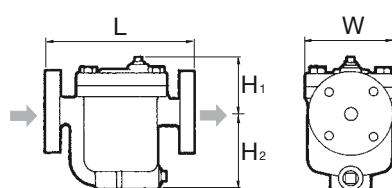

AV

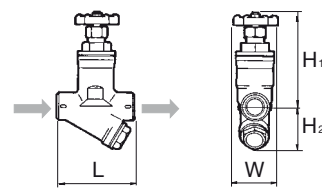

Model	Connections	Size (in)	Max. Operating Pressure		Max. Operating Temperature		Dimensions (mm)				Dimensions (in)				Body Material	Weight	
			MPa	psig	°C	°F	L	H1	H2	W	L	H1	H2	W		kg	lb
AE8-	2	1/2"	0,01 - 0,2	1.5 - 29	350	662	130	73	90	100	5.1	2.9	3.5	3.9	Ductile Cast Iron FCD450	3,7	8.1
		3/4"									5.3					3,9	8.6
		1"									5.3					3,9	8.6
		1/2"									0,1 - 0,97					1.5 - 140	350
3/4"	5.3	3,9	8.6														
1"	5.3	3,9	8.6														
1/2"	0,01 - 0,2	1.5 - 29	350	662	175	73	90	100	6.9	2.9		3.5	3.9	5,3			
3/4"									7.7	2.7	3.7	5,7		12.5			
1"									8.5	2.7	3.7	6,8		15.0			
1/2"									0,1 - 0,97	1.5 - 140	350	662		175	73	90	100
3/4"	7.7	2.7	3.7	5,7	12.5												
1"	8.5	2.7	3.7	6,8	15.0												
1/2"	0,1 - 0,97	1.5 - 140	150	302	110	155	65	65					4.3				
3/4"									4.7	2.6	2.6	2,5	5.5				
1"									4.7	2.8	2.6	2,7	5.9				
1"									4.7	2.8	2.6	2,7	5.9				